

CONSUMER WARRANTY & SERVICE INFORMATION

*Distributors ONLY warrant products with an active
Warranty Registration*

ALWAYS ACTIVATE YOUR WARRANTY IMMEDIATELY ON
<https://yamahaseascooters.com/pages/warranty-1>

Distributors in the United States and Canada provide a Standard Limited Warranty for 6 months from the date of purchase for new products. If you're not located in the United States or Canada, please contact your Local Distributor for warranty arrangements in your territory. Please visit www.seascooter.net for Distributor / Service Center details. Distributors ONLY warrant Yamaha Seascooter products purchased from an authorized dealer and with an original purchase receipt. All warranties are limited to a single original owner on the purchase of new and current product from an authorized reseller. Closeouts, Discontinued and Secondary sales of any kind including "like new" or out of box are not eligible for warranty consideration.

This warranty gives the consumer specific legal rights, and those rights may vary from place to place. Ask your Local Distributor for the warranty period in your region by calling their Service Center. Any part of the product supplied by the Distributor and found in the reasonable judgment of the Distributor to be defective in material or workmanship will be repaired or replaced then returned by the Distributor without charging for parts and repair costs. The product including any defective part must be sent to the Distributor within the warranty period. The customer will pay for the expense of delivering the product to the Distributor.

This warranty does not cover any product that has been subject to misuse negligence or accident, or that has been operated in any way contrary to the operating instructions as specified in the User Manual. Any flood, loss or damage, for any reason, that is caused by accidental release and sinking of the unit, or from flooding an o-ring sealed or water tight area will not be covered under warranty. This warranty does not apply to theft, loss, abuse or tampering, lack of maintenance, improper storage, exposure to excessive temperature, extended sunlight, material interactions, deteriorating chemicals or fumes, any damage to the product that is the result of improper maintenance or parts replacement performed by someone other than the official Distributor Service Center or to any product that has been altered or modified so as to change its intended use. This warranty does not extend to repairs made necessary by normal wear or by the use of parts or accessories which are either incompatible with the product or adversely affects its operation, performance or durability.

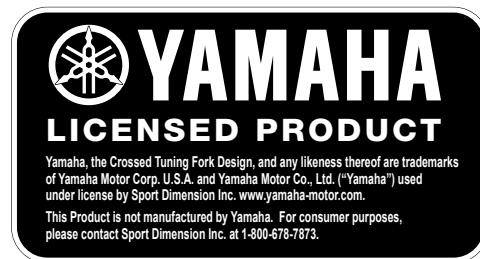

YAMAHA

LICENSED PRODUCT

SEA WING II

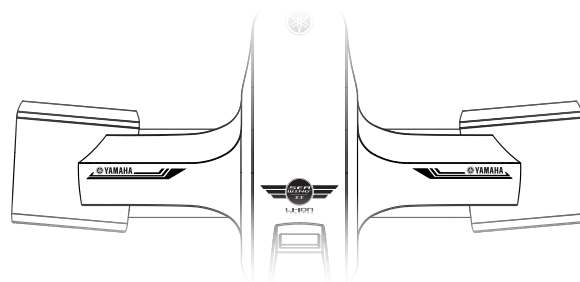

User Manual
English Version

BC

CAUTION

ELECTRICALLY OPERATED PRODUCT

Not recommended for children under 16 years of age. As with all electrical products, precautions should be observed during handling to reduce the risk of electric shock.

SEE NEXT PAGE

Contents

Introduction	1
Warnings	2
Parts Diagram	5
Battery Instruction	6
Getting Started	7
Battery Use	8
Care & Maintenance	11
Camera Assembly	12
Technical Specifications	13



Discarded electrical appliances are recyclable and should not be discarded in the domestic waste! Please actively support us in conserving resources and protecting the environment by returning this appliance to the collection centers (if available).



Introduction

The dual thruster Yamaha SEAWING II is a full-featured Seascooter that gets you cruising underwater with a top speed up to 5mph (8km/h). Easily shift between 2 rotational speeds as you conserve your energy for more bottom time.

Use appropriate equipment such as wetsuit, approved life jacket, mask & snorkel etc. when using Seascooter.

Only operate the Seascooter in water.

- Run time up to 40 minutes
- Rated to 100ft / 30m
- Speed up to 5 MPH / 8 KM/H
- 2-level rotational speed control
- Battery & speed level indicator on OLED
- Superior flood prevention system
- Powered by high performance replaceable Lithium-Ion battery
- Weight only 8.15 lb / 3.7 kg including battery



The Seascooter is designed for use in seawater. It will have less buoyancy in fresh water, lake or pool and may sink in such waters.

Warning

- The Seascooter is designed for 1 person use
- The Seascooter is not a life saving device. Do not use it as a buoyancy aid
- **When passing on this device, include the user manual and all relevant warning information and parts.**
- **It is the responsibility of the owner to give proper instruction and precaution (regarding the risk associated with this device) when lending the device to other people.**

⚠ Warnings



- This is not a life saving device. DO NOT use it as a buoyancy aid.



- Be careful when you are transporting the Seascooter and setting it down to avoid crushing hazard on hands, foot or toes.



- Crushing / Cutting Hazard



- Read the user's manual carefully before use.



- Always follow this age recommendation: a child under 16 years old should never operate this SEASCOOTER™.
- The Seascooter is designed for 1 person use.



- ALWAYS wear a life vest (personal floatation device - PFD) approved by your local authorities for Snorkeling: (U.S. Coast Guard Type III vest in the US or Canadian Coast Guard approved life vest in Canada or SAI Approval PFD in Australia or ISO/CE Approved PFD in Europe).



- Always inspect the swimming area to ensure it is free of hazards or obstacles such as boats and swimmers before using the SEASCOOTER™.



- Particular care should be exercised when using the SEASCOOTER™ near anybody with long hair. Users with long hair should tie it up or wear a swimming cap when using the SEASCOOTER™.



- Never stick body parts, clothing or other objects in the vicinity of the Propeller. Do not wear loose or flowing clothing or equipment that could be drawn into the propeller.



- Be aware of appropriate water levels, tidal changes, dangerous currents, weather change and strong offshore winds. ALWAYS scout unfamiliar water before venturing out.

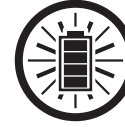

- Always ensure sufficient charge remains in the battery to return to the shore surface before using the Seascooter.



- Do not use alcohol or drugs prior to and during use of this product.



- Do not attach your body, clothing, other equipment to the seascooter in any way.

CAUTION:

- NEVER remove the grilles except for maintenance.
- Familiarize yourself with the Seascooter functions and battery life before embarking on any dives or excursions.
- Always charge battery to its fullest before using the Seascooter.
- Do not allow sun tan oils or lotions to be in prolonged contact with the Seascooter plastic as it may cause the plastic to become brittle and break apart.
- ALWAYS keep the Seascooter out of direct sunlight when not in use. HEAT KILLS BATTERIES AND IT MAY EXPLODE OR LEAK.
- Never open the Battery Compartment of the Seascooter in the water.
- When not in use, always turn the Master Switch to the OFF position.
- Do not use the Seascooter below the recommended maximum depth of 100ft / 30m.
- This machine is not intended for mixing or working with sand, concrete and material with similar physical characteristics. This machine is only intended for swimming and diving in the water.
- Do not use the unit if it is damaged in any way.
- Replace the battery immediately if it is damaged.
- The Seascooter should only be used for scuba diving by qualified divers.
- When using the Seascooter for scuba diving, ascents and descents should be made in accordance with recognized diving practices.
- Due to safety considerations those who have not obtained a C-Card (attesting to completion of training) from an entity providing diving instruction must not under any circumstances use this product for diving.
- In different waters (seawater, lake, pool) and conditions such as currents, temperature and pressure can affect the buoyancy of the unit which may cause the unit to sink if accidentally released.
- DO NOT release or leave the Seascooter in the water. Always take the unit out of water when not in use.

Parts Diagram

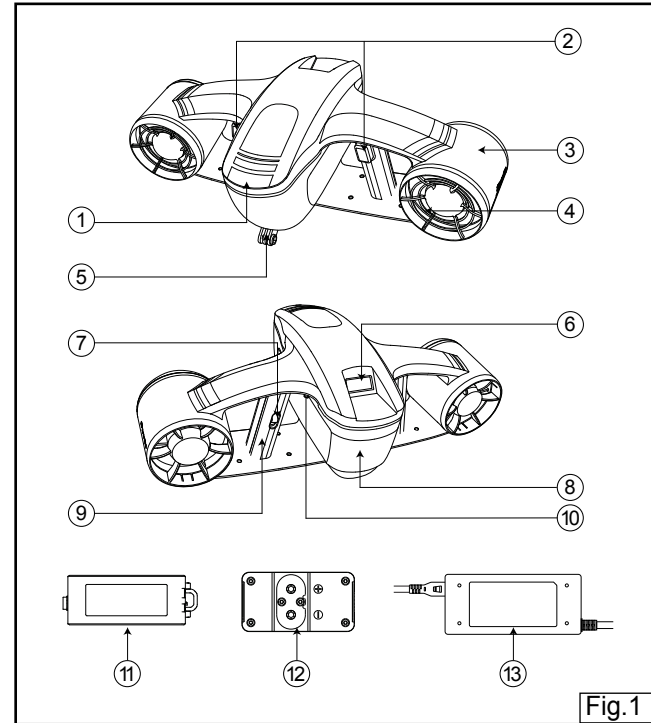

Fig.1

- | | |
|---|---------------------|
| 1. Buoyant Cabin | 7. Safety Lock |
| 2. Start Button | 8. Control Cabin |
| 3. Thrusters | 9. Handle |
| 4. Safety Net | 10. Speed Control |
| 5. Sports Camera (Self-purchased)
Hanging Position | 11. Battery |
| 6. OLED Dashboard | 12. Charger |
| | 13. Charger Adaptor |

Battery Instruction

⚠ WARNING!

Replace the battery immediately if it is damaged.

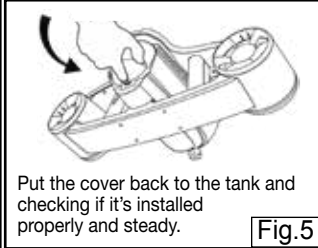
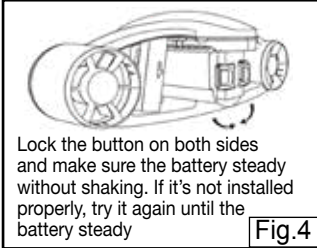
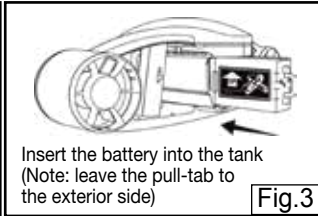
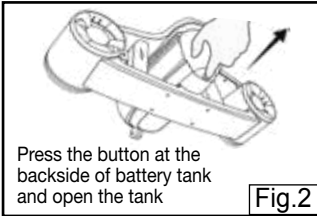

Charging instructions

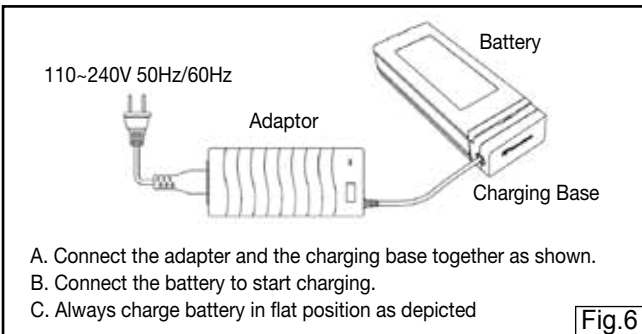

Getting Started

⚠ WARNING!

Please try to test the machine before use it at the first time.

(Note : DO NOT KEEP THE PROPELLERS RUNNING FOR MORE THAN ONE MINUTE IF IT'S NOT IN THE WATER.)

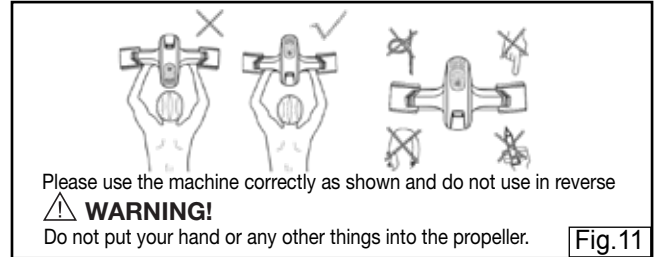
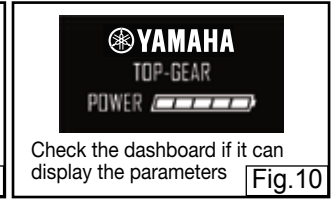
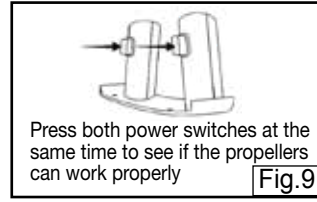
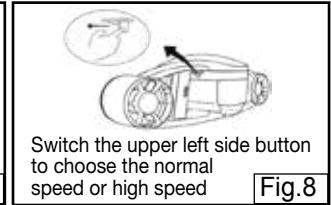
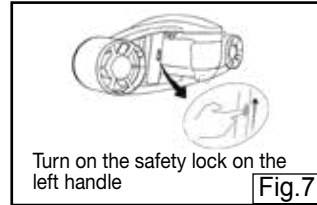

Notes:

1. If there is no operation for a long time, the product will be turned off automatically. Please turn off the safety lock before you put it away.
2. Please do not replace the battery in water. Please remove the battery and clean the machine with fresh water after using, and keep the machine in cool and ventilated place.

Battery Use

CAUTION

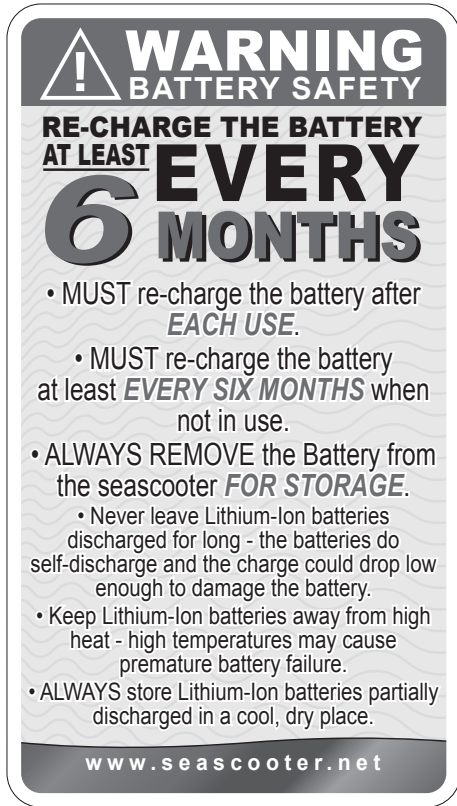

WARNING
BATTERY SAFETY

**RE-CHARGE THE BATTERY
AT LEAST EVERY
6 MONTHS**

- **MUST** re-charge the battery after *EACH USE*.
- **MUST** re-charge the battery at least *EVERY SIX MONTHS* when not in use.
- **ALWAYS REMOVE** the Battery from the seascooter *FOR STORAGE*.
 - Never leave Lithium-Ion batteries discharged for long - the batteries do self-discharge and the charge could drop low enough to damage the battery.
 - Keep Lithium-Ion batteries away from high heat - high temperatures may cause premature battery failure.
- **ALWAYS** store Lithium-Ion batteries partially discharged in a cool, dry place.

www.seascooter.net

Battery Use

CAUTION

- Use the specified charger only.
- Must be disposed of properly.
- Always store the battery in well ventilated areas where it is out of the reach of children and away from heat and ignition sources.
- Do not incinerate, disassemble, damage, short-circuit or expose to heat.
- The battery contains safety and protection devices which, if damaged, may cause the battery to generate heat, rupture or ignite.
- Do not place the battery in fire, direct sunlight or apply heat to the battery; it may explode or leak.
- Do not leave the battery in direct sunlight or use or store the battery inside high temperature containers. Doing so may cause the battery to generate heat, rupture, or ignite. Using the battery in this manner may also result in a loss of performance and a shortened life expectancy.
- Do not place the battery on or near fires, stoves, or other high temperature locations.
- **DO NOT THROW WATER ON A BURNING LI-ION BATTERY.** If an exposed battery does ignite, it will burn even more violently if it comes into contact with water or even the moisture in air. A fire extinguisher must be used.
- Do not expose the battery to water or salt water, or allow the battery to get wet.

Battery Use

CAUTION

- Do not subject the battery to strong impacts or shocks.
- Do not pierce the battery with nails, strike the battery with a hammer, step on the battery, or otherwise damage the outer casing.
- MUST re-charge the battery after EACH USE.
- MUST re-charge the battery at least EVERY SIX MONTHS when not in use.
- ALWAYS REMOVE the battery from the Seascooter FOR STORAGE.
- Never leave Lithium-Ion batteries discharged for long - the batteries do self-discharge and the charge could drop low enough to damage the battery.
- Keep Lithium-Ion batteries away from high heat - high temperatures may cause premature battery failure.
- ALWAYS store Lithium-Ion batteries partially discharged in a cool, dry place.

Care & Maintenance

Washing and Care

- Soak the Seascooter into fresh water for approx. 1 hour after every use to prevent salt-sand and chlorine crystal accumulation in the Seascooter. Or switch the Seascooter on for approx. 1 minute in fresh water to flush the Seascooter and propeller components clear of any debris.

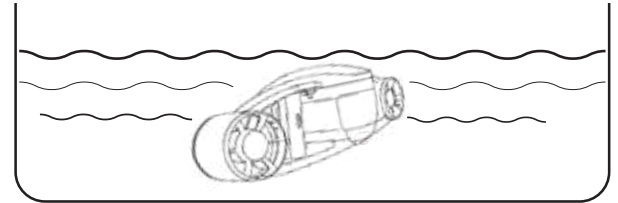

- To clean the Seascooter do not use detergents; only use a damp cloth to wipe the unit clean.
- Use a cloth to dry the Seascooter and the battery compartment.
- DO NOT leave the Seascooter in the water. Always take the unit out of water when not in use.

Sand or Grit on Seals

Ensure that sand/grit does not get on the seals as correct maintenance and care is essential. To remove sand or grit from the seals, rinse the seals in fresh water and apply fresh lubricant. If there is sand inside the Battery Housing, gently brush the sand from the unit taking care not to scratch the sealing surfaces.

Camera Assembly

ATTACHING YOUR CAMERA TO SEASCOOTER MOUNTS (Can be used with GoPro® HERO [3, 3+, 4, 5, 6 or 7] cameras, or other camera with using the same mount system)

To attach your camera to Seascooter Seal and Explorer, you will need a thumb screw or hardware depending on the mount you are using.

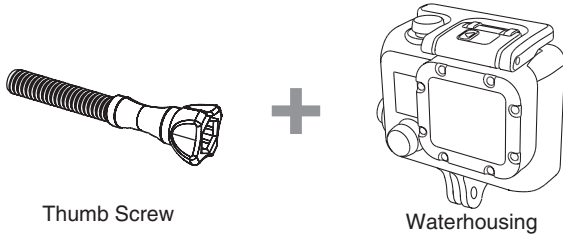

Simply attach the Camera to the mount and align the hole, Insert And Tighten Up The Thumb Screw

*Camera (and Waterhousing), Attachment Buckle and Thumb Screw are not included

Technical Specifications

 WEIGHT 8.15 LB / 3.7 KG	 16+	 DEPTH 100 FT / 30 M	 RUN TIME 40 MINUTES
 SPEED UP TO 5 MPH / 8 KMH	 GEAR 2 SPEED	 RECHARGE 3 HOURS	 BATTERY 14.8V / 10 AH
 HAND-CARRY IN YOUR FLIGHT			

Unit Dimensions	20.1 inches x 6.57 inches x 10.83 inches 510 x 167 x 275 mm
Unit Weight	8.15 lb (3.7 kg)
Battery Type	1 x 14.8V / 10 AH rechargeable battery
Battery Life / Fully Charge	Run up to 40 minutes with normal use. Continuous use up to 30 minutes.
Speed	Up to 5 mph (8 km/h)
Depth rating	30 m / 100 ft (Maximum advised depth rating for recreational diving)

*Normal Use

The definition of normal use is based on the average general time of use the user activates the Seascooter in the water.

△Continuous Use

The definition of continuous use is based on a fully charged battery whereby the Seascooter is used continuously in the water without stopping.

**For more information on
Seascooter™ Products
(Warranty, Customer Care / Maintenance,
Parts & Battery Purchase)**

PLEASE VISIT

www.yamahaseascooters.com

All corresponding specification appear in this manual are correct at the time of printing.
For the latest updates and further information on the complete range of the Seascooter™,
PLEASE VISIT www.yamahaseascooters.com

Yamaha, the Crossed Tuning Fork Design, and any likeness thereof are trademarks of
Yamaha Motor Corp. U.S.A. and Yamaha Motor Co., Ltd. (“Yamaha”) used
under license by Sport Dimension Inc. www.yamaha-motor.com.

This Product is not manufactured by Yamaha. For consumer purposes,
please contact Sport Dimension Inc. at 1-800-678-7873.

(US & CANADA MARKET ONLY)

Please visit our website at www.yamahaseascooters.com to find out your local distributor.

Products covered by the following patents:

USA, Canada, EU, Australia, Japan, Hong Kong, China & Turkey
US D471,506S / US D518,768S / D527,702S / US D506,176S / US D507,776S
D512,678S / D519,911S / 6848385 B2 / US 7000559 B2 / US 7093554 B1 / 11/102,302
0500577.8 / 0500578.0 / 0500579.2 / HK1072691 / ZL200530005661.5
ZL200430079550.4 / ZL200430057359.X / ZL200530005662.X / ZL200530005663.4
ZL200320103738.8 / ZL200520008894.5 / 1194933 / 1254107 / 1225250
000330311-0001 / 000183900-0001 / 000183900-0002 / 000330279-0001
000330295-0001 / 03020902.7 / 302949 / 302564 / 302563 / 302950
302948 / 2005100230 / 200503474 / 29/268,724 / 11/595,675 / 000816376-0001

US & CANADA MARKET ONLY

Toll Free (US) : 1-800-678-7873

service@yamahaseascooters.com

www.yamahaseascooters.com

In addition, this warranty does not cover items that experience normal wear and tear.

ALL IMPLIED WARRANTIES ARE LIMITED IN THE DURATION TO THE WARRANTY PERIOD. AND SUCH IMPLIED WARRANTIES INCLUDING MERCHANTABILITY, FITNESS FOR A PARTICULAR PURPOSE, OR OTHERWISE, ARE DISCLAIMED IN THEIR ENTIRETY AFTER THE EXPIRATION OF THE APPROPRIATE WARRANTY PERIOD. THE DISTRIBUTOR'S OBLIGATION UNDER THE WARRANTY IS STRICTLY AND EXCLUSIVELY LIMITED TO THE REPAIR OR REPLACEMENT OF DEFECTIVE PARTS AND RETURN OF THE PRODUCT TO THE CUSTOMER. THE DISTRIBUTOR DOES NOT ASSUME OR AUTHORIZE ANYONE TO ASSUME FOR THEM ANY OTHER OBLIGATION.

THE DISTRIBUTOR ASSUMES NO RESPONSIBILITY FOR INCIDENTAL, CONSEQUENTIAL OR OTHER DAMAGES INCLUDING, BUT NOT LIMITED TO EXPENSE OF RETURNING THE PRODUCT TO THE DISTRIBUTOR, LOSS OF USE OF PRODUCT AND LOSS OF TIME OR INCONVENIENCE.

THIS PRODUCT IS DESIGNED AND INTENDED FOR PERSONAL RECREATIONAL USE ONLY!

THIS PRODUCT IS NOT WARRANTED FOR COMMERCIAL OR RENTAL USE!

REPAIR WORK OR DELIVERY OF A REPLACEMENT DOES NOT EXTEND OR RENEW THE WARRANTY PERIOD.

WARRANTY SHALL AUTOMATICALLY BE VOID IF DAMAGE IS RESULT OF NON-ORIGINAL PARTS.

LIMITED WARRANTY for seascooters with camera mount:

- ALWAYS inspect to ensure the product works properly every time before use. Warranty of this product does not cover any damages due to misuse.
- Failure to follow the user(s) instructions on packaging and/or user(s) manual may result in damages or loss of your cameras including but not limited to any user's personal items, all of which are not covered under warranty of this product.
- Use at your own risk. Manufacturer(s) and/or suppliers/agents are not responsible for any damages/repairs, loss to cameras/electronic items including but not limited to any user's personal items directly and/or indirectly resulted in the use of this product. Damage(s) resulting from any use, misuse, accident, and normal wear and tear are understandably not covered under this product warranty nor be responsible by manufacturer(s) and/or suppliers/agents.

EXCLUSIONS

BATTERY. This warranty does not include the battery.

Never replace the original SEASCOOTER BATTERY with an AFTERMARKET BATTERY. Seascooter with aftermarket battery will not be covered by this warranty.

CUSTOMER ENQUIRIES

If your unit is not operating, please refer to your User Manual before contacting our Customer Service Center. For any damage or repair work required, please do not return your product to the store where it was purchased.

RETURN / REPAIR POLICY

Customers must contact their Local Distributor Service Center to ask for an official Claim Form. The Claim Form must be returned with the customer's contact details and a photo of the Seascooter, defective parts, the serial number and the Original Purchase Receipt. The Distributor Customer Service Center will review the case and issue a Return / Repair Authorization Number before sending the product to the Distributor Service Center. Returned products must be shipped with original packaging including the polystyrene packing material and all defective parts. Please contact your Local Distributor Service Center for assistance in handling your case.

Please visit our website www.yamahaseascooters.com for a listing of most update distributor contacts and service center contacts.

RETURN / REPAIR PROCEDURE

1. Call the Customer Service Center for your Return / Repair Authorization Number.
2. Make a copy of your Proof of Purchase (receipt).
3. Pack the defective unit in its original packaging including the polystyrene foam and include the unit and all defective parts.
4. Attach the copy of your Proof of Purchase (receipt) to the outside of the box (clearly visible), together with the Return / Repair Authorization Number.
5. Ship the package to the Service Center on your cost.

PLEASE NOTE: Deliveries that do not have the Proof of Purchase (receipt) and Return / Repair Authorization Number attached clearly to the outside of the box, will not be accepted by the Service Center.

For any questions or queries you may have regarding your SEASCOOTER™, please follow the below steps for easy and fast resolution:

- STEP 1-

Please read your User Manual. For a copy of the User Manuals, please visit www.yamahaseascooters.com

- STEP 2-

Go to www.yamahaseascooters.com and see our FAQ section to find instant answers.

- STEP 3-

Contact one of our Customer Service representatives at the Customer Service Center in your region.